



MK3404

N-Channel 30-V(D-S) MOSFET

| | | |
|-----------------|-------------------|-------------|
| V(BR)DSS | RDS(on)MAX | ID |
| 30 V | 25mΩ@10V | 5.8A |
| | 37mΩ@4.5V | |

FEATURE:

※ TrenchFET Power MOSFET

DESCRIPTION :

The MK3404 use advanced trench technology to provide excellent RDS(ON) and low gate charge. This device is suitable for use as a load switch or in PWM applications. The source leads are separated to allow a Kelvin connection to the source, which may be used to bypass the source inductance.

MARKING:

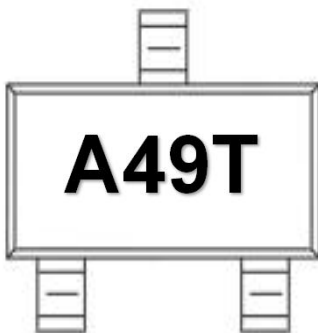

Equivalent Circuit:

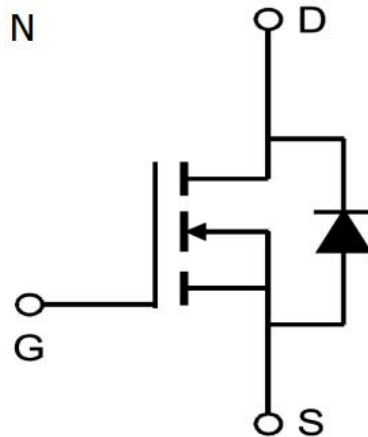

SOT-23

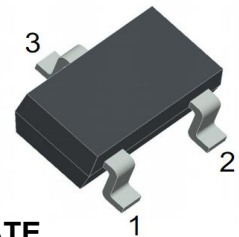

- 1.GATE
- 2.SOURCE
- 3.DRAIN

Mosfet Maximum ratings (Ta=25°C unless otherwise noted)

| Parameter | Symbol | Value | Unit |
|---|--------|----------|------|
| Drain-Source Voltage | VDS | 30 | V |
| Gate-Source Voltage | VGS | ±20 | |
| Continuous Drain Current | ID | 5.8 | A |
| Pulsed drain current * | IDM | 30 | |
| Power Dissipation | PD | 1.4 | W |
| Thermal Resistance from Junction to Ambient | RθJA | 357 | °C/W |
| Junction Temperature | TJ | 150 | °C |
| Storage Temperature | TSTG | -55~+150 | °C |

* Repetitive rating : Pulse width limited by maximum junction temperature.



MOSFET ELECTRICAL CHARACTERISTICS

Static Electrical Characteristics (Ta = 25 °C Unless Otherwise Noted)

| Parameter | Symbol | Test Condition | Min | Typ | Max | Unit |
|------------------------------------|----------|--------------------------------------|-----|------|------|------|
| Static Parameters | | | | | | |
| Drain-source breakdown voltage | V(BR)DSS | VGS = 0V, ID =250μA | 30 | | | V |
| Gate-threshold voltage | VGS(th) | VDS =VGS, ID =250μA | 1 | | 2.5 | V |
| Gate-body leakage | IGSS | VDS =0V, VGS =±20V | | | ±100 | nA |
| Zero gate voltage drain current | IDSS | VDS =30V, VGS =0V | | | 1 | μA |
| Drain-source on-resistancea | RDS(on) | VGS =10V, ID = 5.8A | | 18 | 25 | mΩ |
| | | VGS =4.5V, ID = 4.8A | | 27 | 37 | mΩ |
| Forward transconductancea | gfs | VDS =4.5V, ID = 5.8A | | 22 | | S |
| Diode forward voltage | VSD | IS= 1A,VGS=0V | | 0.8 | 1.28 | V |
| Dynamic Parameters | | | | | | |
| Input capacitance | Ciss | VDS =15V, VGS =0V, f=1MHz | | 373 | 448 | pF |
| Output capacitance | Coss | | | 67 | | pF |
| Reverse transfer capacitanceb | Crss | | | 41 | | pF |
| Gate resistance | Rg | VDS =0V,VGS =0V,f =1MHz | | 1.8 | 2.8 | Ω |
| Switching Parameters | | | | | | |
| Turn-on delay time | td(on) | VGS=10V, VDS=15V RL=2.6Ω, RGEN=3Ω | | 4.5 | 6.5 | ns |
| Rise time | tr | | | 2.4 | | ns |
| Turn-off delay time | td(off) | | | 14.8 | | ns |
| Fall time | tf | | | 2.5 | | ns |
| Total gate charge | Qg | VDS = 15V,VGS = 10V, ID =5.8A | | 7.1 | 11 | nC |
| Gate-source charge | Qgs | | | 1.4 | | nC |
| Gate-drain charge | Qgd | | | 1.7 | | nC |
| Body Diode Reverse Recovery Time | Trr | IF= 5.8A, dI/dt=100A/μs | | 10.5 | | ns |
| Body Diode Reverse Recovery Charge | Qrr | IF= 5.8A, dI/dt=100A/μs | | 4.5 | | nC |

Note :

1. These parameters have no way to verify.
2. Pulse Test ; Pulse Width ≤300μs, Duty Cycle ≤0.5%.



SOT-23 PACKAGE OUTLINE DIMENSIONS

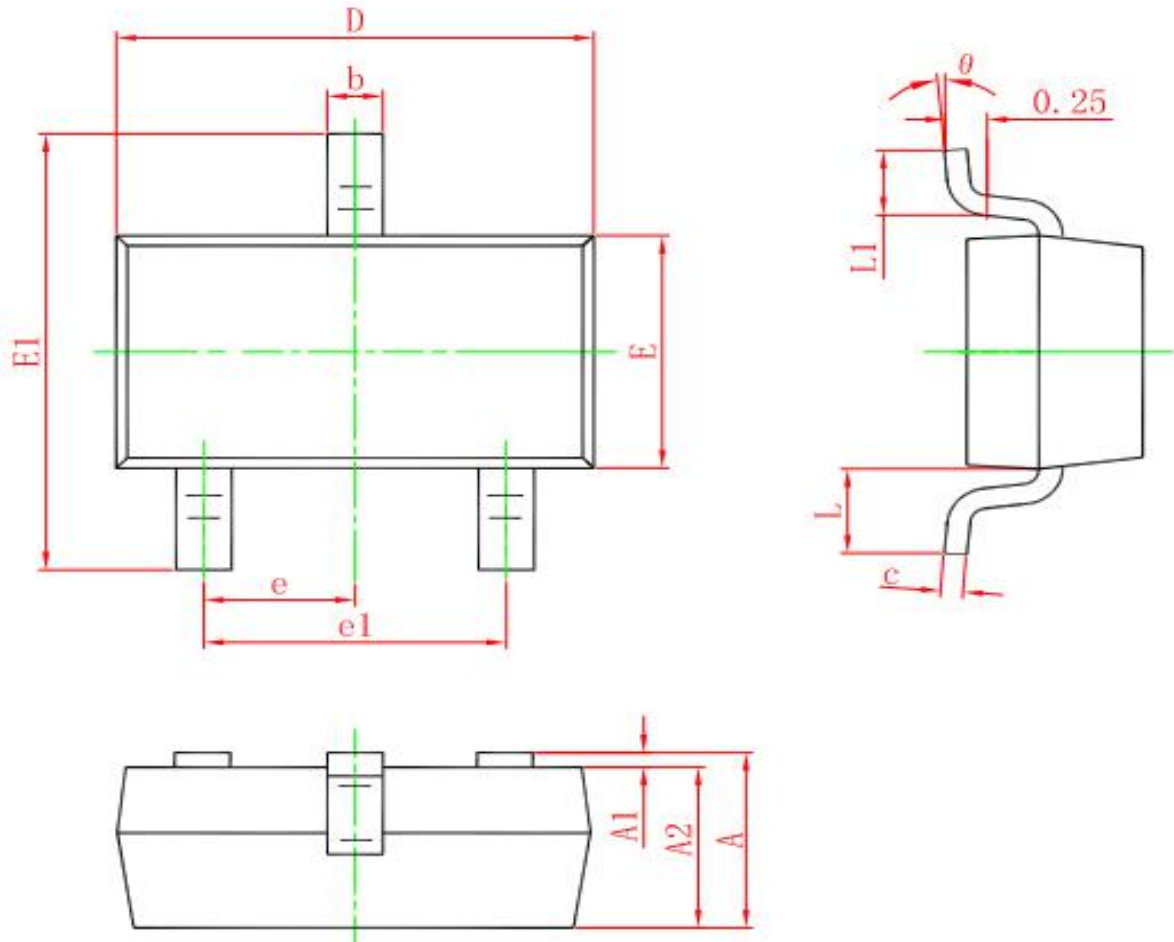

| Symbol | Dimensions In Millimeters | | Dimensions In Inches | |
|----------|---------------------------|-------|----------------------|-------|
| | Min. | Max. | Min. | Max. |
| A | 0.900 | 1.150 | 0.035 | 0.045 |
| A1 | 0.000 | 0.100 | 0.000 | 0.004 |
| A2 | 0.900 | 1.050 | 0.035 | 0.041 |
| b | 0.300 | 0.500 | 0.012 | 0.020 |
| c | 0.080 | 0.150 | 0.003 | 0.006 |
| D | 2.800 | 3.000 | 0.110 | 0.118 |
| E | 1.200 | 1.400 | 0.047 | 0.055 |
| E1 | 2.250 | 2.550 | 0.089 | 0.100 |
| e | 0.950 TYP. | | 0.037 TYP. | |
| e1 | 1.800 | 2.000 | 0.071 | 0.079 |
| L | 0.550 REF. | | 0.022 REF. | |
| L1 | 0.300 | 0.500 | 0.012 | 0.020 |
| θ | 0° | 8° | 0° | 8° |



TYPICAL ELECTRICAL AND THERMAL CHARACTERISTICS

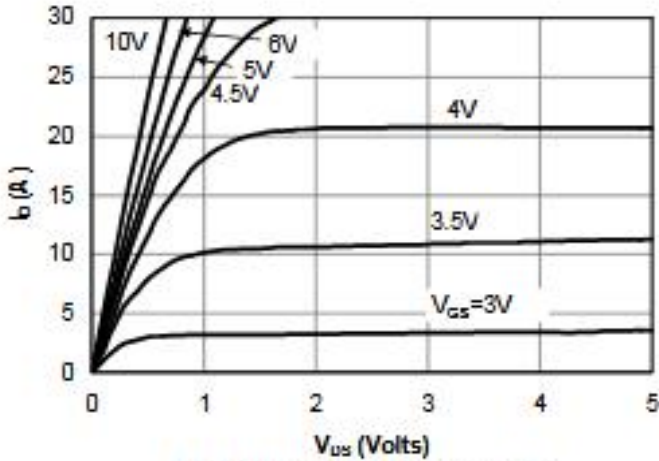

Fig 1: On-Region Characteristics

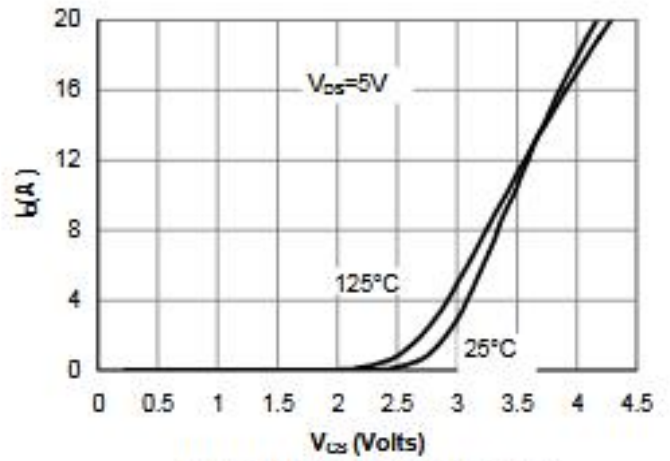

Figure 2: Transfer Characteristics

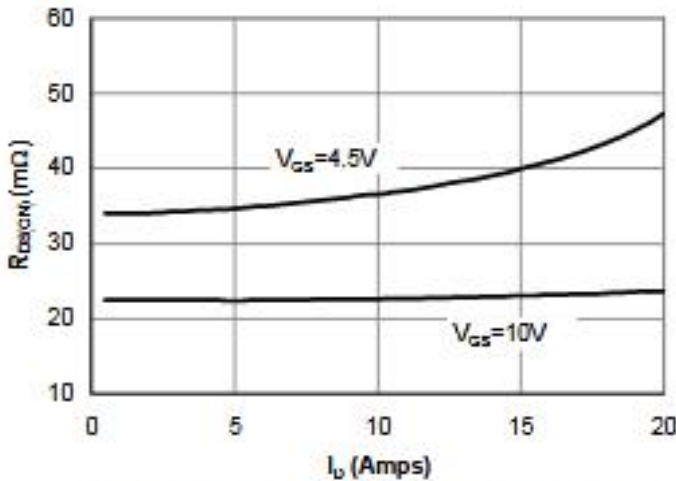

Figure 3: On-Resistance vs. Drain Current and Gate Voltage

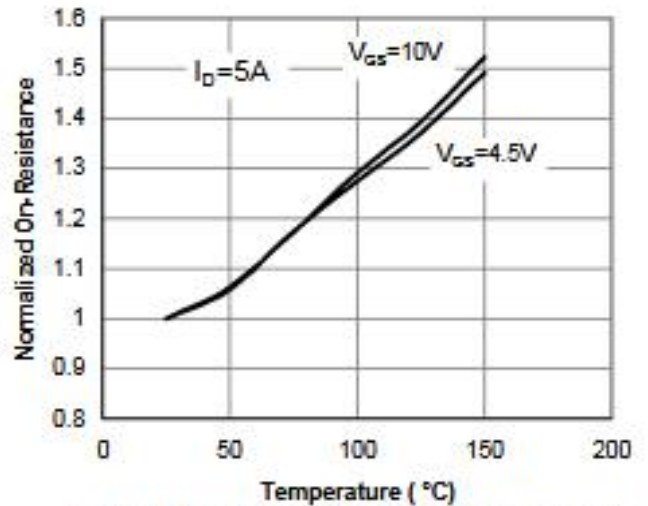

Figure 4: On-Resistance vs. Junction Temperature

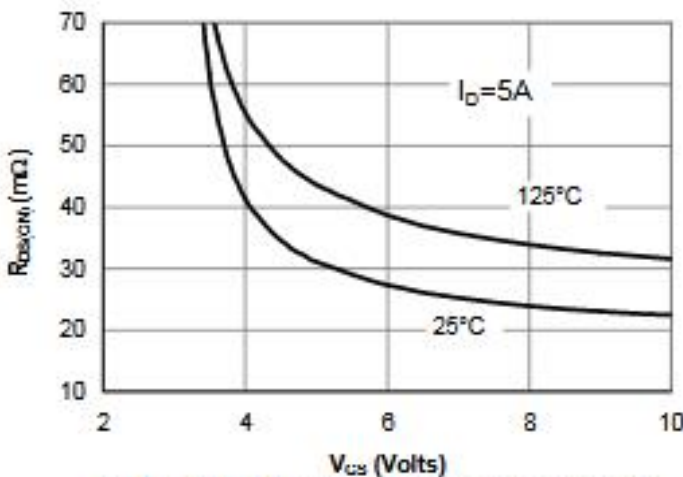

Figure 5: On-Resistance vs. Gate-Source Voltage

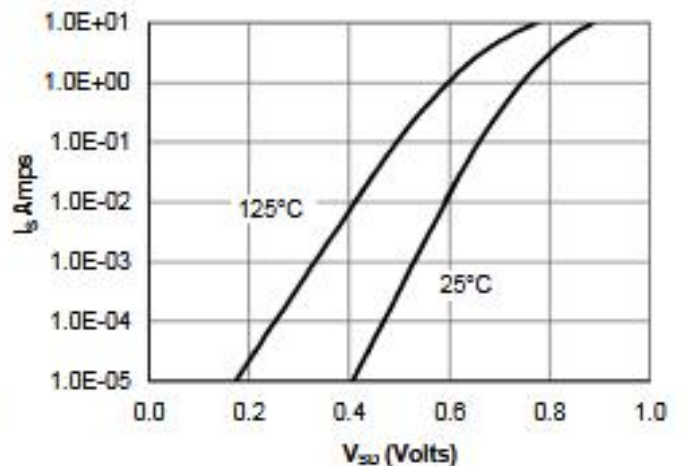

Figure 6: Body diode characteristics



TYPICAL ELEC TRICAL AND THERMAL CHARACTERISTICS

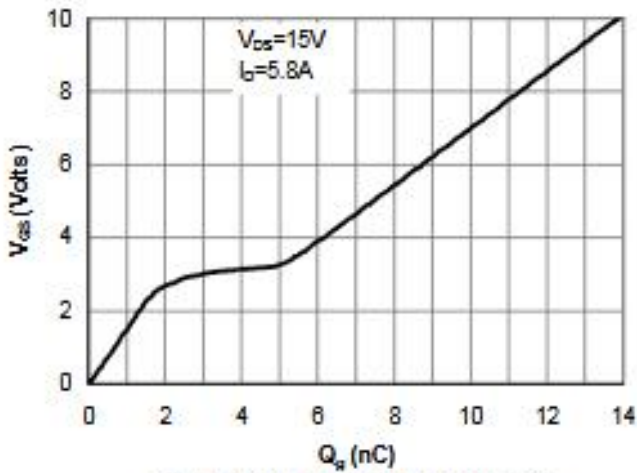

Figure 7: Gate-Charge characteristics

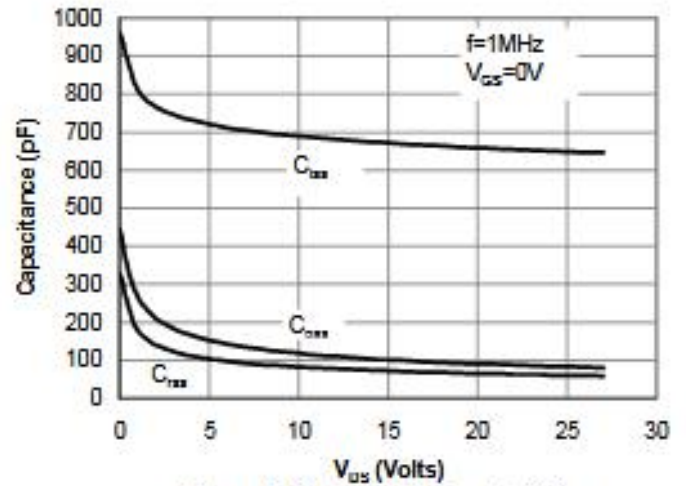

Figure 8: Capacitance Characteristics

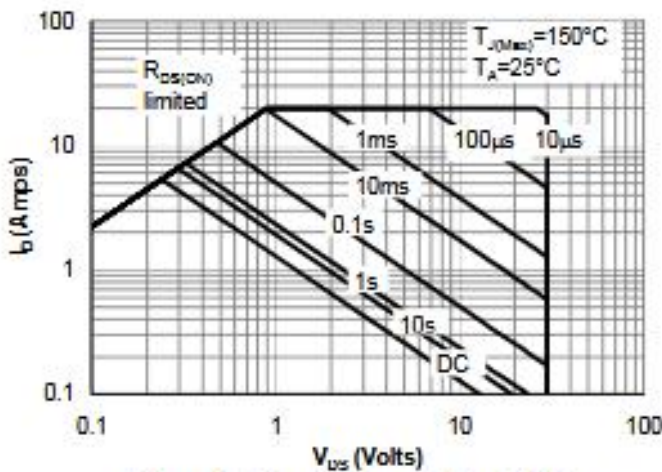

Figure 9: Maximum Forward Biased Safe Operating Area (Note E)

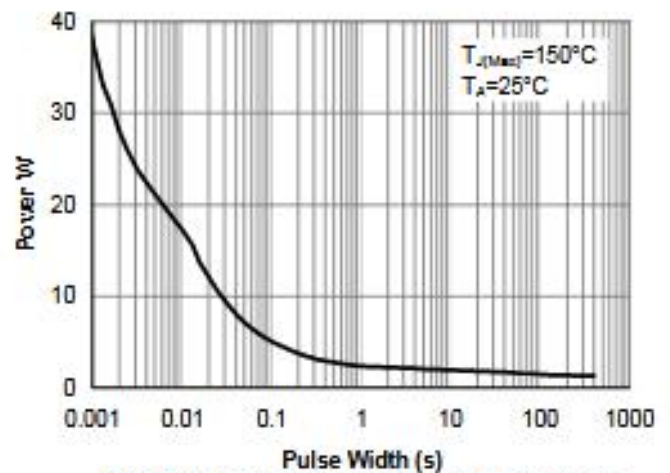

Figure 10: Single Pulse Power Rating Junction-to-Ambient (Note E)

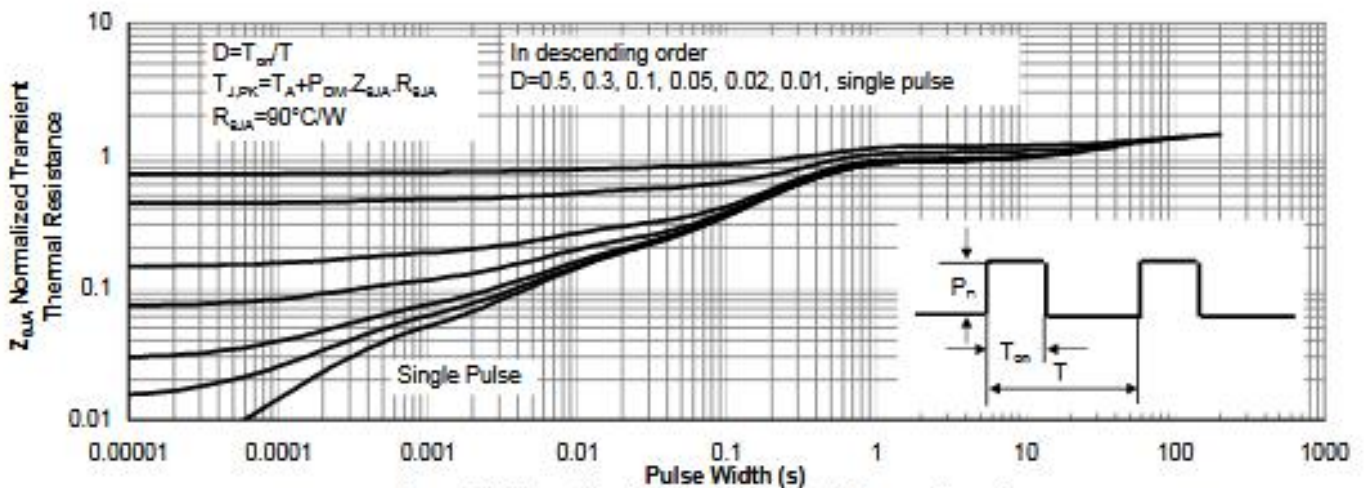

Figure 11: Normalized Maximum Transient Thermal Impedance